

# KEYLESS360

THE PERFECT LOCK

✓ SIMPLE ✓ SUSTAINABLE ✓ SECURE

## SIMPLY PERFECT. PERFECTLY SIMPLE.

**SIMPLE** to install and operate, this alphanumeric combination lock is the Ultimate Retrofit. With a standard 3-hole routing, the Keyless360 is the easiest plug and play solution.

**SUSTAINABLE** with a solid metal design and no batteries, wires, or harmful waste these locks qualify for two LEEDV4 credits.

**SECURE** with anti-pick technology and patented Master Key and Breakaway Knob systems these locks will protect your lockers from forced entry and tampering.



## OUR CLIENTS



amazon

BOEING

Capital One

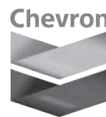

Coca-Cola



EQUINOX

facebook



Google

HYATT



LIFETIME FITNESS



Mercedes-Benz



PEPSICO



REBEL



VISA



# KEYLESS360 INSTRUCTIONS

## USER INSTRUCTIONS





See Demonstration  
Video

## TO LOCK

1. Close the door.
2. Make sure knob is pointing up to , then set any 2-digit code.
3. Turn knob to .
4. Scramble the dials.

## TO UNLOCK

1. Re-enter your code.
2. Turn the knob up to .
3. Open the door.
4. Keeping the knob facing , scramble the dials for the next user.



## MANAGER INSTRUCTIONS



See Demonstration  
Video

## MASTER KEY CODE BYPASS

(immediate manager access without code obstruction)



1. Insert the Master Key pointing towards the .
2. Turn the knob to  and access the locker, then close the door while keeping the knob facing .



3. Return the knob to the  position, and remove the key.

*\*Locker will remain locked and code will remain the same.*

## USER CODE RETRIEVAL & RESET

(retrieve forgotten user code and reset code for new user)

1. Insert the Master Key pointing towards the  and turn the knob to .
2. With each dial: spin until it stops.
  - After setting each dial, the last used code will display.

3. Turn the knob back to  and remove the key.
  - Then, return the knob to  and scramble the dials for the next user.

# KEYLESS360 FINISH OPTIONS

Premium and custom finishes have longer lead times; warranty subject to availability.  
10% color discrepancy, and custom pricing options apply.



MODEL:  
**KEYLESS360-SN**

SATIN NICKEL  
STANDARD FINISH



MODEL:  
**KEYLESS360-MB**

MATTE BLACK  
PREMIUM FINISH



MODEL:  
**KEYLESS360-MW**

MATTE WHITE  
PREMIUM FINISH

# KEYLESS360 ARCHITECTURAL SPECIFICATIONS



MODEL:  
**KEYLESS360-SN**  
SATIN NICKEL

The Keyless360 can be custom finished to any brand style with a wide array of customizable finish options.  
(All specs and features apply)

## SPECIFICATIONS

- Shared (temporary) or assigned (permanent) use
- 2-digit alphanumeric combination
- Compatible with wood, glass, plastic, phenolic & metal locker doors
- Zero operating expenses - no batteries or wires
- LEED V4 - adds 2 LEED credits
- 5-year comprehensive warranty
- One Master Key has 3 functions: bypasses the code, resets the lock, and retrieves the code - all conveniently from the front
- Lock features reprogrammable-cylinder. When Master Key is lost or stolen, new Master Key is issued. Simply insert new Master Key and cylinder is reprogrammed - patented solution
- Anti-pick and tamper resistant
- Self-correcting, Breakaway Knob protects against forced entry - patented solution
- IP69K - Complete dust and water resistance
- Strong 100% metal for long-term and heavy-use - no plastic components.
- The same lock model with ADA lever available

## ADDITIONAL FEATURES

- Sleek and modern design
- Standard, premium & custom finishes
- Large, clear combination digits, double the size of any competitors (5mm tall), that don't fade
- Sufficient digit and dial spacing that prevents accidental lockouts
- Strongest latch (bolt) in the industry and cannot be forced unlocked
- Dead bolt or spring bolt latch type (standard offset: 31mm - addtl available)
- Simple 2 screw installation
- Surface mounted
- Accommodates doors 1-21mm thickness
- Standard vertical 3-hole routing
- Easy 2-screw plug and play
- Easily retrofits from most locks on most locker doors. "The Ultimate Retrofit Lock"
- Ergonomic non-slip grip
- One step twist-&-pull operation
- Knob rotates 90 degrees (from 12 o'clock to 3 o'clock) on left and right hand locks
- Latch is simply interchangeable to left or right
- Clear locked and unlocked status indicator is visible from a distance
- **Immediate live response during business hours - no run around.**  
([sos@keyless.co](mailto:sos@keyless.co) or 972.331.2770)

### LOCK ROUTING

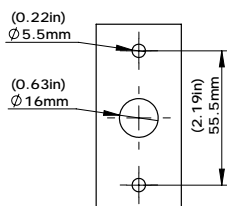

### TOP VIEW 6-21mm THICK DOOR

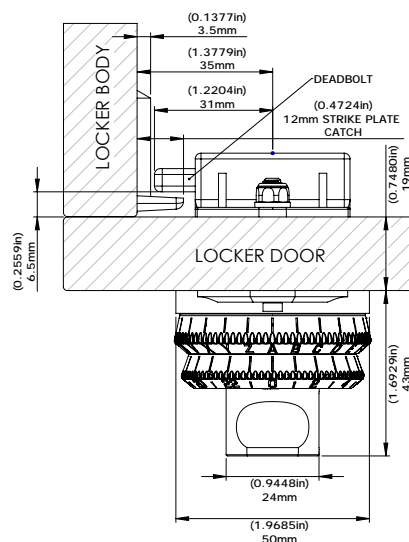

### TOP VIEW 1-6mm THICK DOOR

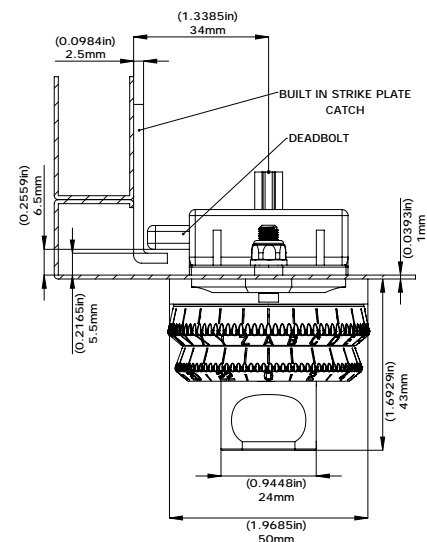

**ADA OPTION AVAILABLE**

Manufactured By:

**KEYLESS.CO**

1825 W. Walnut Hill Ln., Suite 102, Irving, TX 75038, USA | +1 972-331-2770 | [info@keyless.co](mailto:info@keyless.co) | [www.keyless.co](http://www.keyless.co)

# KEYLESS360-ADA ARCHITECTURAL SPECIFICATIONS



MODEL:  
**KEYLESS360-SN-ADA**  
SATIN NICKEL

The Keyless360 can be custom finished to any brand style with a wide array of customizable finish options. (All specs and features apply)

## SPECIFICATIONS

- Meets the 2010 and 2012 Standards for Accessible Design
- The same lock model with ADA lever available
- Integrated lever serving as a pull
- Shared (temporary) or assigned (permanent) use
- 2-digit alphanumeric combination
- Compatible with wood, glass, plastic, phenolic & metal locker doors
- Zero operating expenses - no batteries or wires
- LEED V4 - adds 2 LEED credits
- 5-year comprehensive warranty
- One Master Key has 3 functions: bypasses the code, resets the lock, and retrieves the code - all conveniently from the front
- Lock features reprogrammable-cylinder. When Master Key is lost or stolen, new Master Key is issued. Simply insert new Master Key and cylinder is reprogrammed - patented solution
- Anti-pick and tamper resistant
- Self-correcting, Breakaway Knob protects against forced entry - patented solution
- IP69K - Complete dust and water resistance
- Strong 100% metal for long-term and heavy-use - no plastic components.
- The same lock model with ADA lever available

## ADDITIONAL FEATURES

All additional features of the Keyless1-ADA are exactly the same as the Keyless1 non-ADA.

## 2010 & 2012 ADA STANDARDS FOR ACCESSIBLE DESIGN REQUIREMENTS

- 5% of lockers and their operable parts, the locks, must meet ADA specifications.
- Locks shall be operable with one hand.
- Shall not require tight grasping, pinching, or twisting of the wrist to operate.
- Shall have a force required to activate of 5lbs (22.2N) maximum.
- Locks shall be installed maximum 48.00"/1220mm from the floor surface.

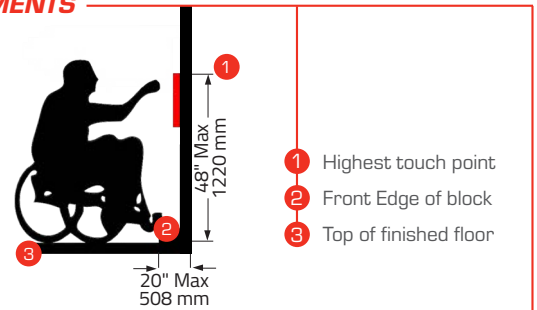

### LOCK ROUTING

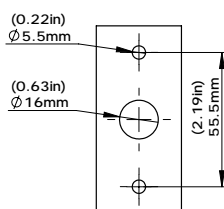

### TOP VIEW 6-21mm THICK DOOR

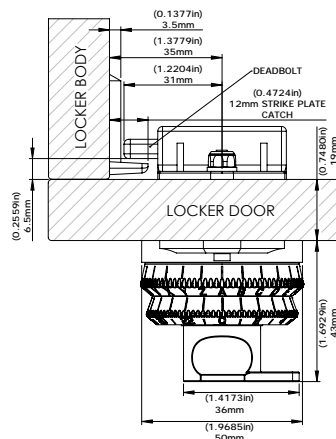

### TOP VIEW 1-6mm THICK DOOR

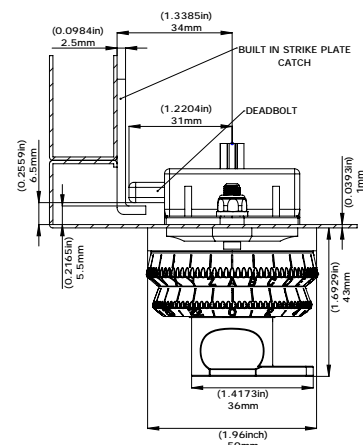

Manufactured By:

**KEYLESS.CO**

1825 W. Walnut Hill Ln., Suite 102, Irving, TX 75038, USA | +1 972-331-2770 | info@keyless.co | www.keyless.co