

RaptorRAC™

W I D E S P A N S H E L V I N G

PRODUCT
CATALOG



TABLE OF CONTENTS

TECH DATA	3 - 7
TECHNICAL SPECIFICATIONS	5 - 6
DIMENSIONS	8
HOW TO ORDER <i>with the aid of Configura</i>	9
UPRIGHTS	10
BEAMS	11
DECKING	12 - 13
FRONT TO BACK SUPPORTS	14
ACCESSORIES	14
PART NUMBERS REFERENCE GUIDE	15

TECH DATA

SHELVING SYSTEMS

RaptorRAC™

W I D E S P A N S H E L V I N G

Shelving built to last, with infinite possibilities.

Spacesaver's rugged and versatile wide span shelving provides a perfect platform for storing countless items. Whether it's parachutes on a military base, evidence in a police station, stock in an industrial warehouse, or large artifacts in a museum setting, RaptorRAC™ shelving offers a sturdy way to protect the stuff that's important. It is designed to work great both in static applications as well as integrate with Spacesaver's wide range of industry-leading mobile systems. The wide range of size options of RaptorRAC™ wide span shelving can easily be configured to optimally store items of all shapes and sizes.

FEATURES & BENEFITS

1. **Strength and Durability:** RaptorRAC storage systems feature a roll-formed boxed style upright post design that provides optimum structural integrity under load. Horizontal "Z" beam design provides the required strength and stability to support loads over wide spans. All welded upright frames and beam construction meets AWS D1.3 certified welding standards.
2. **Versatility:**
 - RaptorRAC storage system features two upright design options to provide maximum versatility when designing your storage requirements.
 - Option 1: Fully welded uprights with 2" (50.8 mm) by 1-9/16" (39.69 mm) boxed posts
 - Option 2: Knocked down uprights with 2" (50.8 mm) x 1-9/16" (39.69 mm) boxed posts and bolt on horizontal ladder braces
 - RaptorRAC storage system features three different beam options: Heavy Duty, Standard Duty, and Low Profile, to provide maximum versatility when designing your storage requirements.
 - RaptorRAC storage system features five different decking options to meet your storage needs: Solid Steel, Particle Board, Ribbed, Wire Waterfall, and Flat Wire.
3. **Flexibility/Adjustability:**
 - Easy assembly, can be quickly installed, expanded, or relocated
 - Beams can be easily adjusted vertically, no tools required for adjustment, assembly, or disassembly
 - Large variety of upright, beam, and decking size options
4. **Accessories:** Anchor feet, Front to Back supports, Upright Splices, Back to Back supports, Back to Wall supports, and Tie Plates allow customization to virtually any need, in any space.
5. **Color Options:** RaptorRAC storage system is available in all Spacesaver Mobile and Shelving powder coat paint color options.



DESIGN AND CAPABILITIES

- 2" (50.8 mm) wide cold-rolled steel box-formed posts and welded truss style upright frames provide the structural integrity needed to support demanding storage requirements.
- Wide variety of upright frame heights, 60" (1524.0 mm) to 144" (3657.6 mm), and depths, 15" (381.0 mm) to 48" (1219.2 mm), to meet customer storage requirements.
- Upright design allows for 1-1/2" (38.1 mm) vertical adjustment of horizontal beams.
- Three beam size options are available to optimize space and loading requirements.
- Beam design offers configured sizes in 1" (25.4 mm) increments between 48" (1219.2 mm) and 96" (2438.4 mm) in length.
- Five different decking options to accommodate different material being stored.
- Anchor Feet are available for anchoring upright frames to either the floor or mobile carriage platform.
- Upright splices can be used to integrate two uprights together vertically.
- Tie Plates, Back to Back, Back to Wall, Back to Back Tie Plates are all available to increase the support, stability, and configurability of the RaptorRAC storage system.

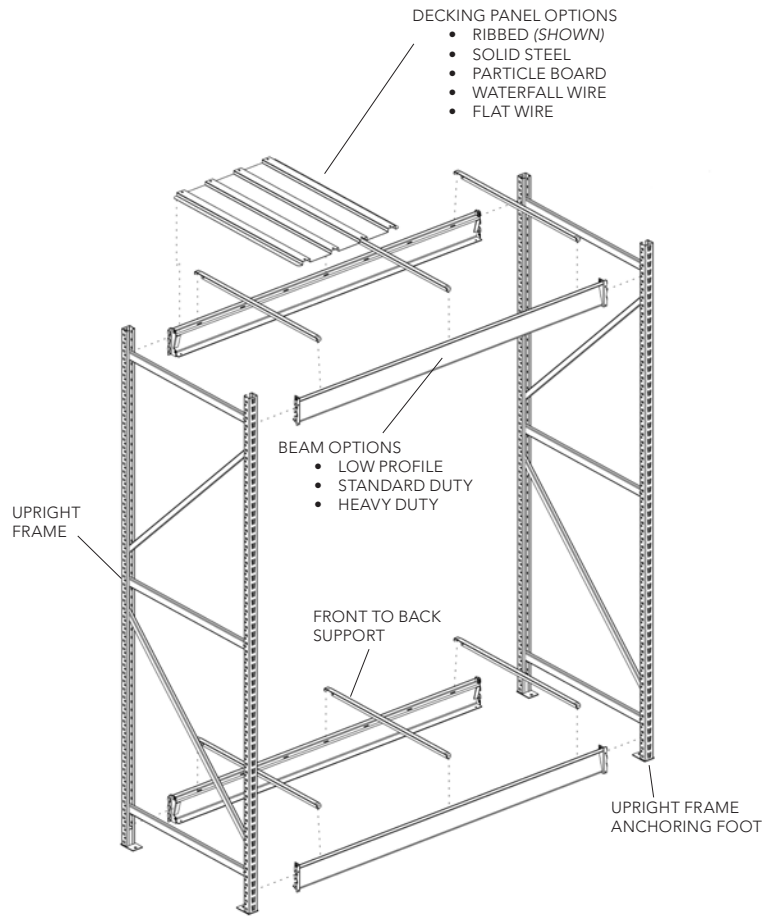

APPLICATION

- RaptorRAC storage system can be used as standalone shelving or mobilized on Spacesaver carriages for maximum space efficiency. The system was designed to accommodate storage needs where 4-Post and Pallet Racking do not meet the exact customer needs or space requirements.
- RaptorRAC storage system is the ideal choice for back room and warehouse applications within healthcare, museum and archive, government and justice, military, law enforcement, and correctional facilities.



TECHNICAL SPECIFICATIONS

RaptorRAC™ WIDE SPAN SHELVING SYSTEM

UPRIGHTS:

WELDED UPRIGHT frames shall be a welded truss design similar to that used for pallet rack. Upright frame posts shall be 14-gauge (1.90 mm) steel, box-formed, 2" (50.8 mm) by 1-9/16" (39.69 mm), designed with notches on the front face of post, located on 1-1/2" (38.1 mm) centers, to allow for easy adjustment of horizontal load bearing beams. Sides of post shall have notches, located on 1-1/2" (38.1 mm) centers, to accommodate anchor feet, supports, tie plates, and securing beams to post. Horizontal braces shall be 14-gauge (1.90 mm) steel, roll-formed 1-1/2" (38.1 mm) by 3/4" (19.05mm) tube MIG welded to posts. Diagonal braces shall be 14-gauge (1.90 mm) steel, roll-formed 1" (25.4 mm) by 3/4" (19.05mm) open channel MIG welded to posts. All welded upright frame construction shall meet AWS D1.3 certified welding standards.

KNOCK-DOWN frame shall be a bolt together design utilizing vertical post and horizontal ladder bracing. Upright posts shall be 14-gauge (1.90 mm) steel, box-formed, 2" (50.8 mm) by 1-9/16" (39.69 mm), designed with notches on the front face of post, located on 1-1/2" (38.1 mm) centers, to allow for easy adjustment of horizontal load bearing beams. Sides of post shall have notches, located on 1-1/2" (38.1 mm) centers, to accommodate anchor feet, supports, tie plates, and securing beams to post. Horizontal ladder brace component shall be 12-gauge (2.66 mm) steel with two integral lances and one 5/16" (7.94 mm) hole on each end to engage and secure to vertical post.

U.S. CUSTOMARY UNITS (INCHES)	
Standard Depths	15", 18", 24", 30", 36", 42", 48"
	With configured depths on 1" increments
Standard Heights	60", 72", 84", 96", 120", 144"
	With configured heights on 1-1/2" increments

METRIC DIMENSIONS (mm)	
Standard Depths	381.0mm, 457.2mm, 609.6mm, 762.0mm, 914.4mm, 1066.8mm, 1219.2mm
	With configured depths on 25.4mm increments
Standard Heights	1524.0mm, 1828.8mm, 2133.6mm, 2438.4mm, 3048.0mm, 3657.6mm
	With configured heights on 38.1mm increments

Capacity ratings for all uprights:

UPRIGHT CAPACITY RATINGS	
All Sizes	8500 lb capacity with bottom beam in 1st or 2nd position above floor and 36" maximum beam spacing
	7000 lb capacity with bottom beam 36" maximum above floor and 36" maximum beam spacing
*Capacities listed are for minimum of 2 beam levels with evenly distributed loads. Designed and tested with 1.8 safety factor.	

BEAMS:

LOW PROFILE BEAMS shall be 12-gauge (2.66 mm) steel with "Z"-shaped structural design. Overall height of beam shall be 2" (50.8 mm) nominal. Each beam shall have punch slots along its length to accommodate front to back shelf supports; length and location length dependent to support shelving load requirements. Beam mounting end brackets shall be manufactured from 12-gauge (2.66 mm) material and welded to each end of the beam. All welded upright beam construction shall meet AWS D1.3 certified welding standards.

LOW PROFILE CAPACITY RATINGS					
Width	48"	60"	72"	84"	96"
Capacity	675 lb	525 lb	450 lb	375 lb	325 lb

STANDARD DUTY BEAMS shall be 14-gauge (1.90 mm) steel with "Z"-shaped structural design. Overall height of beam shall be 3-5/8" (92.1 mm) nominal. Each beam shall have slots punched along its length to accommodate front to back shelf supports; length and location of supports are dependent on shelving load requirements. Beam mounting end brackets shall be manufactured from 12-gauge (2.66 mm) material and welded to each end of the beam. All welded upright beam construction shall meet AWS D1.3 certified welding standards.

STANDARD DUTY CAPACITY RATINGS					
Width	48"	60"	72"	84"	96"
Capacity	3300 lb	2600 lb	1900 lb	1775 lb	1650 lb

HEAVY DUTY BEAMS shall be 12-gauge (2.66 mm) steel with "Z"-shaped structural design. Overall height of beam shall be 4-5/8" (117.48 mm) nominal. Each beam shall have slots punched along it, length to accommodate front to back shelf supports; length and location of supports are dependent on shelving load requirements. Beam mounting end brackets shall be manufactured from 12-gauge (2.66 mm) material and welded to each end of the beam. All welded upright beam construction shall meet AWS D1.3 certified welding standards.

HEAVY DUTY CAPACITY RATINGS					
Width	48"	60"	72"	84"	96"
Capacity	3300 lb	3300 lb	3300 lb	3300 lb	3300 lb

Capacities listed per pair of beams with evenly distributed loads and required number of Front To Back Supports. Beams have been designed and tested with L/180 maximum deflection and 1.65 safety factor.

Specifications are subject to change.

TECHNICAL SPECIFICATIONS

RaptorRAC™ WIDE SPAN SHELVING SYSTEM

DECKING:

SOLID STEEL DECKING shall be 1-1/4" (31.75 MM) in height and be formed of 18-gauge (1.2 mm) cold rolled steel with flanges on all four sides. Side flanges of decking shall also be turned "down", "in", and "up" to form a "J" style bend. Decking shall be supported, front and rear, by two horizontal beams. Steel decking available in widths of 12" (304.8 mm), 18" (457.2 mm), 24" (609.6 mm), 30" (762.0 mm), and 36" (914.4 mm). Steel decking is also available in 1" (25.4 mm) increments in depths between 15" (381.0 mm) and 48" (1,219.2 mm).

SOLID STEEL DECKING CAPACITY RATINGS

Width	Depth						
	15"	18"	24"	30"	36"	42"	48"
12"	1175 lb	1125 lb	1000 lb	875 lb	750 lb	625 lb	500 lb
18"	1175 lb	1125 lb	1000 lb	875 lb	750 lb	625 lb	500 lb
24"	1175 lb	1125 lb	1000 lb	875 lb	750 lb	625 lb	500 lb
30"	1175 lb	1125 lb	1000 lb	875 lb	750 lb	625 lb	500 lb
36"	1175 lb	1125 lb	1000 lb	875 lb	750 lb	625 lb	500 lb

**Capacities listed are for evenly distributed loads. Designed and tested with L/140 maximum deflection and 1.5 safety factor.*

PARTICLE BOARD DECKING shall be 11/16" (17.46 mm) thick particle board material per ANSI-A208.1-1999 M-3. Particle board decking available in 1" (25.4 mm) increments in widths between 48" (1,219.2 mm) and 96" (2,468.4 mm), and depths between 15" (381.0 mm) and 48" (1,219.2 mm).

PARTICLE BOARD DECKING CAPACITY RATINGS

Width	Depth						
	15"	18"	24"	30"	36"	42"	48"
48"	2000 lb	2000 lb	2000 lb	1675 lb	1350 lb	1025 lb	700 lb
60"	2000 lb	2000 lb	2000 lb	1675 lb	1350 lb	1025 lb	700 lb
72"	3000 lb	3000 lb	3000 lb	2500 lb	2025 lb	1525 lb	1050 lb
84"	3000 lb	3000 lb	3000 lb	2500 lb	2025 lb	1525 lb	1050 lb
96"	3300 lb	3300 lb	3300 lb	3300 lb	2700 lb	2050 lb	1400 lb

**Capacities listed are for evenly distributed loads with required number of Front To Back Supports.*

Specifications are subject to change.

RIBBED DECKING shall be formed from 20-gauge (0.91 mm) cold rolled steel with equally spaced 5/8" (15.85 mm) high by 1-3/4" (44.45 mm) wide structural rectangular ribs running the full depth of the decking. Ribbed decking is available in widths of 24" (609.6 mm) and 36" (914.4 mm). Ribbed decking is also available in 1" (25.4 mm) increments in depths between 15" (381.0 mm) and 18" (1,219.2 mm).

RIBBED DECKING CAPACITY RATINGS

Width	Depth						
	15"	18"	24"	30"	36"	42"	48"
24"	1775 lb	1650 lb	1400 lb	1150 lb	925 lb	675 lb	450 lb
36"	2175 lb	2050 lb	1800 lb	1550 lb	1300 lb	1025 lb	775 lb

**Capacities listed are for evenly distributed loads. Designed and tested with L/140 maximum deflection and 1.5 safety factor.*

WATERFALL WIRE DECKING shall be steel 5-gauge (4.62 mm) wire fabricated on a 2" (50.8 mm) by 4" (104.6 mm) rectangular grid pattern with 1.5" (38.1 mm) front and rear formed flanges. Waterfall wire decking shall have three equally spaced 12-gauge (2.66 mm) steel structural reinforcements placed parallel along the depth of the decking and welded to the wire framing at each intersection. Waterfall wire decking shall be available in widths of 24" (609.6 mm) and 36" (914.4 mm). Waterfall wire decking shall be also available in depths of 24" (609.6 mm), 30" (762.0 mm), 36" (914.4 mm), 42" (1,006.8 mm), and 48" (1,219.2 mm).

WATERFALL WIRE DECKING CAPACITY RATINGS

Width	Depth				
	24"	30"	36"	42"	48"
24"	1550 lb	1325 lb	1100 lb	875 lb	650 lb
36"	1550 lb	1325 lb	1100 lb	875 lb	650 lb

**Capacities listed are for evenly distributed loads. Designed and tested with L/140 maximum deflection and 1.5 safety factor.*

FLAT WIRE DECKING shall be steel 5-gauge (4.62 mm) wire fabricated on a flat 2" (50.8mm) by 4" (104.6 mm) rectangular grid pattern. Flat wire decking shall be available in widths of 24" (609.6 mm) and 36" (914.4 mm). Flat wire decking shall be also available in depths of 24" (609.6 mm), 36" (914.4 mm), and 48" (1,219.2 mm).

FLAT WIRE DECKING CAPACITY RATINGS

Width	Depth				
	24"	30"	36"	42"	48"
24"	120 lb	105 lb	90 lb	75 lb	60 lb
36"	180 lb	155 lb	130 lb	105 lb	80 lb

**Capacities listed are for evenly distributed loads. Designed and tested with L/140 maximum deflection and 1.5 safety factor.*

SHELVING OPTIONS AND ACCESSORIES

Welded Upright



Knock-Down Upright



Knock-Down Ladder Brace



Low Profile Beam



Standard Duty Beam



Heavy Duty Beam



Solid Steel Decking



Particle Board Decking



Ribbed Decking



Waterfall Wire Decking

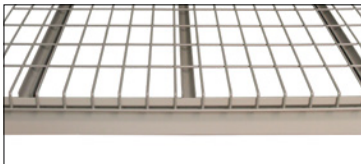

Flat Wire Decking



Front To Back Support



Anchor Foot



Back To Back Tie Plate



Upright Splice



Back To Wall Support



Back To Back Support



DIMENSIONS for RaptorRAC™ Wide Span Shelving

RACK WIDTH

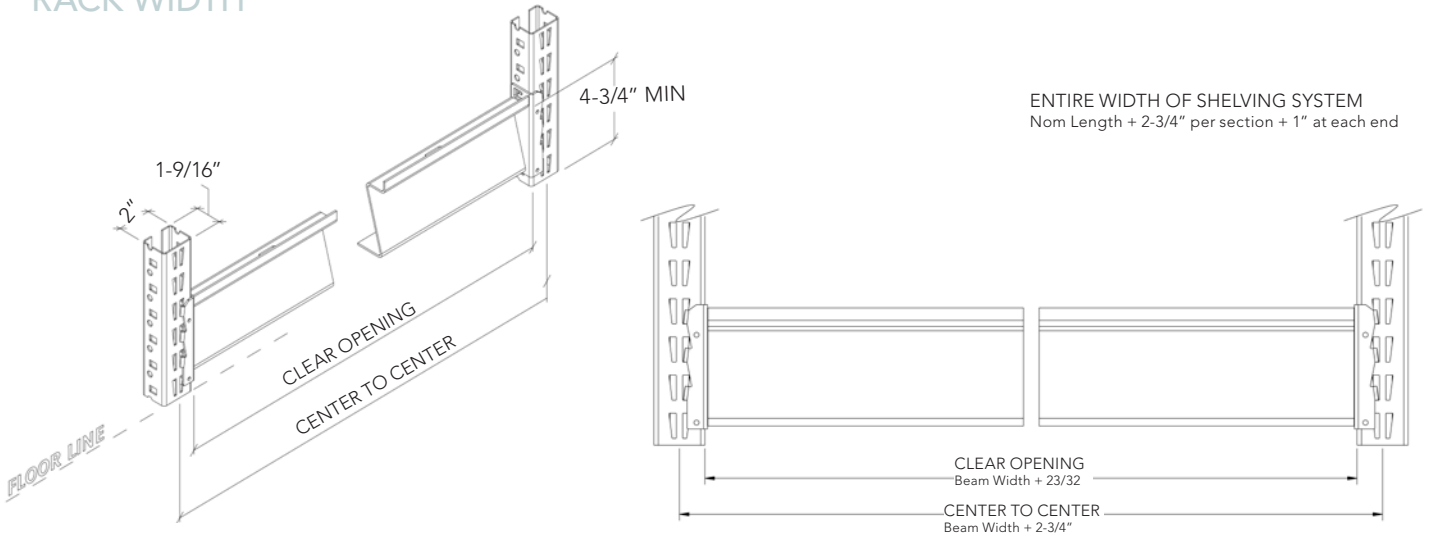

ENTIRE WIDTH OF SHELVING SYSTEM
Nom Length + 2-3/4" per section + 1" at each end

RACK DEPTH

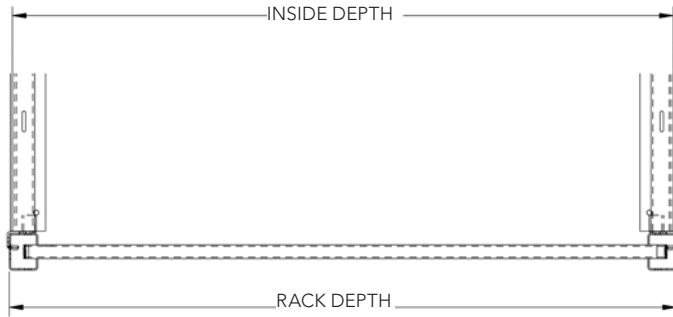

Nominal Depth	Rack Depth	Inside Depth
15"	15 ⁹ / ₁₆ "	15 ¹ / ₄ "
18"	18 ⁹ / ₁₆ "	18 ¹ / ₄ "
24"	24 ⁹ / ₁₆ "	24 ¹ / ₄ "
30"	30 ⁹ / ₁₆ "	30 ¹ / ₄ "
36"	36 ⁹ / ₁₆ "	36 ¹ / ₄ "
42"	42 ⁹ / ₁₆ "	42 ¹ / ₄ "
48"	48 ⁹ / ₁₆ "	48 ¹ / ₄ "

ACCESSORY DIMENSIONS

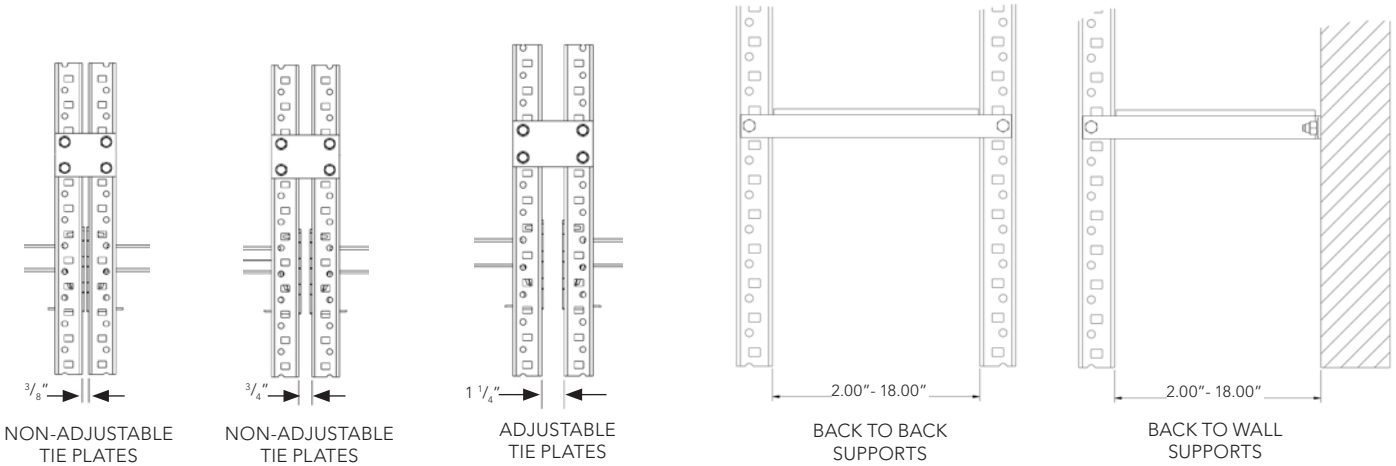

HOW TO ORDER a RaptorRAC™ Wide Span Shelving System

with the aid of Configura

STEP 1

SELECT UPRIGHTS

Select Uprights by size in either, Welded or Knock-Down (KD)

STEP 2

SELECT BEAMS

Select Beam based on width of opening and weight capacity needed:

- Low Profile "Z" Beam
- Standard Duty "Z" Beam
- Heavy Duty "Z" Beam

STEP 3

SELECT DECKING

Select Decking based on size and style desired:

- Solid Steel Decking
- Particle Board Decking
- Ribbed Decking
- Waterfall Wire Decking
- Flat Wire Decking

STEP 4

SELECT FRONT TO BACK SUPPORTS

Select Front To Back Supports based on depth of upright and decking

STEP 5

SELECT ACCESSORIES

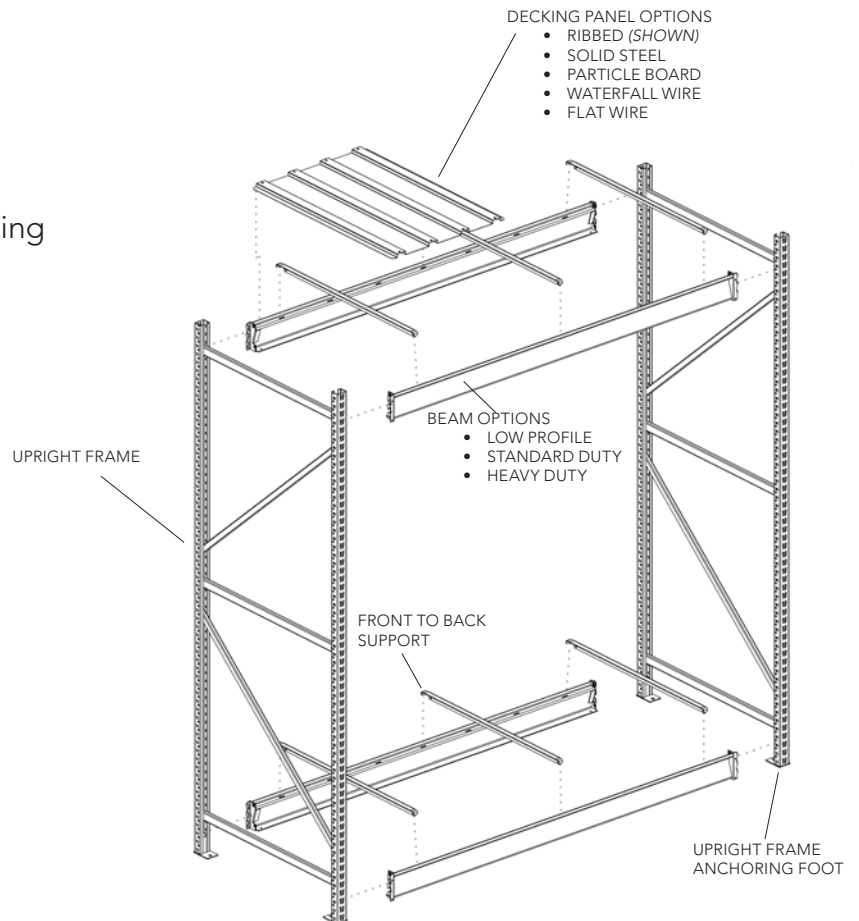

COLOR SELECTION

Available in 30 powder coat paint colors.

Colors are the same as the standard available for Spacesaver's mobile shelving product line.

STEP 1 Select **Uprights**.
Choose *Welded* or *Knock-Down (KD)*

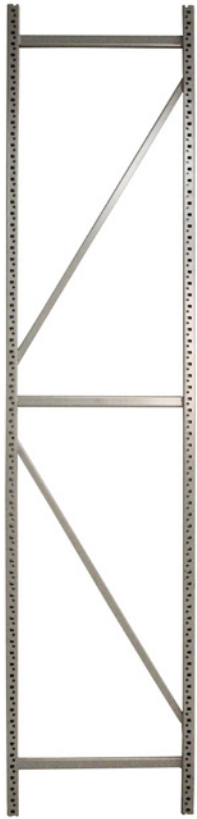

WELDED UPRIGHTS

Welded Uprights have a 14-gauge 1" x 3/4" open channel diagonal brace and a gauge 1 1/2" x 3/4" tube horizontal brace MIG welded to posts.

Posts: 14-gauge, 2" x 1 9/16" box posts, punched on 1 1/2" centers

8,500 lb.
capacity per section

In addition to standard sizes, both Uprights are available in:

- *Depths in 1" increments between 15" and 48"*
- *Heights in 1 1/2" increments between 60" and 144"*

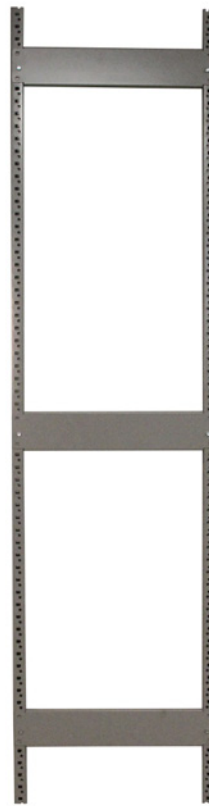

KNOCK-DOWN UPRIGHTS

Knock-Down (KD) Uprights include two posts, and three or more bolt on Ladder Braces.

Posts: 14-gauge, 2" x 1 9/16" box posts, punched on 1 1/2" centers

8,500 lb.
capacity per section

LADDER BRACES ONLY

Length	Part No.
15"	WSLB15
18"	WSLB18
24"	WSLB24
30"	WSLB30
36"	WSLB36
42"	WSLB42
48"	WSLB48

Use as replacement, or as a component.

Upright capacities listed are for minimum of 2 beam levels with evenly distributed loads. With bottom beam in 1st or 2nd position above floor and 36" maximum beam spacing. Designed and tested with 1.8 safety factor. For more information see page 5.

WELDED UPRIGHT PART NUMBERS

Depth	Height		
	60" Part No.	72" Part No.	84" Part No.
15"	WSWU2150600	WSWU2150720	WSWU2150840
18"	WSWU2180600	WSWU2180720	WSWU2180840
24"	WSWU2240600	WSWU2240720	WSWU2180840
30"	WSWU2300600	WSWU2300720	WSWU2300840
36"	WSWU2360600	WSWU2360720	WSWU2360840
42"	WSWU2420600	WSWU2420720	WSWU2420840
48"	WSWU2480600	WSWU2480720	WSWU2480840
Depth	Height		
	96" Part No.	120" Part No.	144" Part No.
15"	WSWU2150960	WSWU2151200	WSWU2151440
18"	WSWU2180960	WSWU2181200	WSWU2181440
24"	WSWU2240960	WSWU2241200	WSWU2241440
30"	WSWU2300960	WSWU2301200	WSWU2301440
36"	WSWU2360960	WSWU2361200	WSWU2361440
42"	WSWU2420960	WSWU2421200	WSWU2421440
48"	WSWU2480960	WSWU2481200	WSWU2481440

KNOCK-DOWN UPRIGHT PART NUMBERS

Depth	Height		
	60" Part No.	72" Part No.	84" Part No.
15"	WSKDU2150600	WSKDU2150720	WSKDU2150840
18"	WSKDU2180600	WSKDU2180720	WSKDU2180840
24"	WSKDU2240600	WSKDU2240720	WSKDU2240840
30"	WSKDU2300600	WSKDU2300720	WSKDU2300840
36"	WSKDU2360600	WSKDU2360720	WSKDU2360840
42"	WSKDU2420600	WSKDU2420720	WSKDU2420840
48"	WSKDU2480600	WSKDU2480720	WSKDU2480840
Depth	Height		
	96" Part No.	120" Part No.	144" Part No.
15"	WSKDU2150960	WSKDU2151200	WSKDU2151440
18"	WSKDU2180960	WSKDU2181200	WSKDU2181440
24"	WSKDU2240960	WSKDU2241200	WSKDU2241440
30"	WSKDU2300960	WSKDU2301200	WSKDU2301440
36"	WSKDU2360960	WSKDU2361200	WSKDU2361440
42"	WSKDU2420960	WSKDU2421200	WSKDU2421440
48"	WSKDU2480960	WSKDU2481200	WSKDU2481440

STEP 2 Select Beams.

Available Beam types:

LOW PROFILE

Ideal for use in commercial applications, our low-profile beams offer a lightweight, high-density solution.

- 12-gauge
- Z-shaped
- 2" overall height

STANDARD DUTY

The horizontal "Z" beam construction of our standard duty beams offer provide the required strength and load capacity, as well as negate beam rotation. Beam clips are mig-welded for added strength, and fold-in lock tabs easily engage to avoid shelf movement.

- 14-gauge
- Z-shaped
- 3 5/8" overall height

HEAVY DUTY

Similar to the construction of our standard duty beams but with even more strength, these beams are ideal for the storage of extremely heavy or bulky items.

- 12-gauge
- Z-shaped
- 4 5/8" overall height

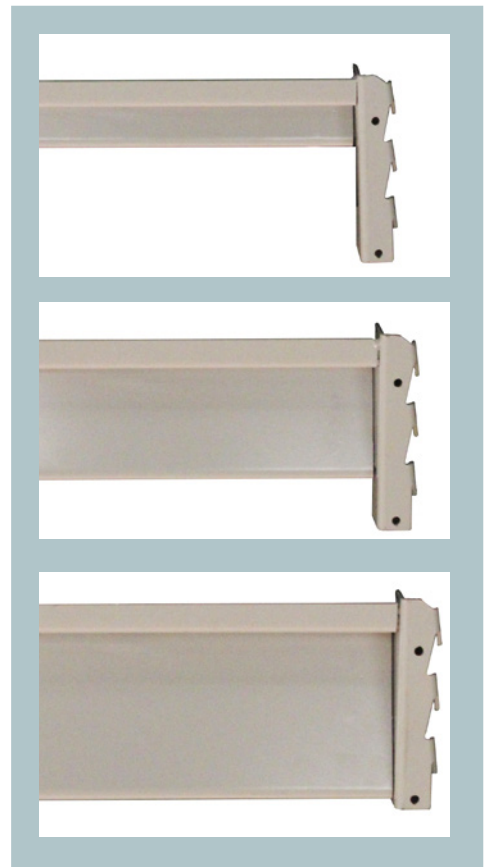

All Beams have 12-gauge brackets, and are punched for Front To Back Supports.

In addition to standard sizes, Beams are available in:

- Widths in 1" increments between 48" and 96"

FEATURES

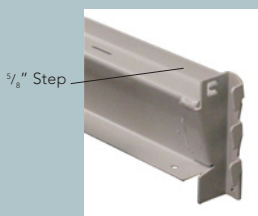

5/8" Step



Fold in Lock Tab

"Z"- Shape

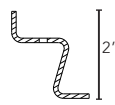

LOW PROFILE

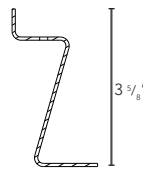

STANDARD DUTY

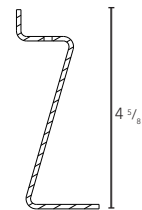

HEAVY DUTY

Benefits of Z-shaped beams:
Increased strength
Reduced beam rotation

BEAM PART NUMBERS & CAPACITIES

Nominal Width	Center to Center Width*	Width of Clear Opening*	LOW PROFILE		STANDARD DUTY		HEAVY DUTY	
			Part No.	Capacity	Part No.	Capacity	Part No.	Capacity
48"	50 3/4"	48 23/32"	WSBLD48	675 lb	WSBS48	3300 lb	WSBHD48	3300 lb
60"	62 3/4"	60 23/32"	WSBLD60	525 lb	WSBS60	2600 lb	WSBHD60	3300 lb
72"	74 3/4"	72 23/32"	WSBLD72	450 lb	WSBS72	1900 lb	WSBHD72	3300 lb
84"	86 3/4"	84 23/32"	WSBLD84	375 lb	WSBS84	1775 lb	WSBHD84	3300 lb
96"	98 3/4"	96 23/32"	WSBLD96	325 lb	WSBS96	1650 lb	WSBHD96	3300 lb

*Center to Center Width refers to the center of one post the center of the next post. Width of Clear Opening refers to the inside of post to the inside of the next post.
**Capacities listed per pair of beams with evenly distributed loads and required number of Front To Back Supports. Designed and tested with L/180 maximum deflection and 1.65 safety factor.

STEP 3 Select Decking.

SOLID STEEL DECKING



Durable 18-gauge steel flange shelves for a flat, smooth decking surface.

In addition to standard sizes, available in:

- Depths in 1" increments between 15" and 48"

SOLID STEEL DECKING PART NUMBERS & CAPACITIES

Width	Depth							
	15"		18"		24"		30"	
	Capacity	Part No.	Capacity	Part No.	Capacity	Part No.	Capacity	Part No.
12"	1175 lb	WSDSS1215	1125 lb	WSDSS1218	1000 lb	WSDSS1224	875 lb	WSDSS1230
18"	1175 lb	WSDSS1815	1125 lb	WSDSS1818	1000 lb	WSDSS1824	875 lb	WSDSS1830
24"	1175 lb	WSDSS2415	1125 lb	WSDSS2418	1000 lb	WSDSS2424	875 lb	WSDSS2430
30"	1175 lb	WSDSS3015	1125 lb	WSDSS3018	1000 lb	WSDSS3024	875 lb	WSDSS3030
36"	1175 lb	WSDSS3615	1125 lb	WSDSS3618	1000 lb	WSDSS3624	875 lb	WSDSS3630

Width	Depth							
	30"		36"		42"		48"	
	Capacity	Part No.	Capacity	Part No.	Capacity	Part No.	Capacity	Part No.
12"	875 lb	WSDSS1230	750 lb	WSDSS1236	625 lb	WSDSS1242	500 lb	WSDSS1248
18"	875 lb	WSDSS1830	750 lb	WSDSS1836	625 lb	WSDSS1842	500 lb	WSDSS1848
24"	875 lb	WSDSS2430	750 lb	WSDSS2436	625 lb	WSDSS2442	500 lb	WSDSS2448
30"	875 lb	WSDSS3030	750 lb	WSDSS3036	625 lb	WSDSS3042	500 lb	WSDSS3048
36"	875 lb	WSDSS3630	750 lb	WSDSS3636	625 lb	WSDSS3642	500 lb	WSDSS3648

PARTICLE BOARD DECKING



Sturdy 11/16" thick particle board decking.

In addition to standard sizes, available in:

- Widths in 1" increments between 48" and 96"
- Depths in 1" increments between 15" and 48"

PARTICLE BOARD DECKING PART NUMBERS & CAPACITIES

Width	Depth							
	15"		18"		24"		30"	
	Capacity	Part No.	Capacity	Part No.	Capacity	Part No.	Capacity	Part No.
48"	2000 lb	WSDPB4815	2000 lb	WSDPB4818	2000 lb	WSDPB4824	1675 lb	WSDPB4830
60"	2000 lb	WSDPB6015	2000 lb	WSDPB6018	2000 lb	WSDPB6024	1675 lb	WSDPB6030
72"	3000 lb	WSDPB7215	3000 lb	WSDPB7218	3000 lb	WSDPB7224	2500 lb	WSDPB7230
84"	3000 lb	WSDPB8415	3000 lb	WSDPB8418	3000 lb	WSDPB8424	2500 lb	WSDPB8430
96"	3300 lb	WSDPB9615	3300 lb	WSDPB9618	3300 lb	WSDPB9624	3300 lb	WSDPB9630

Width	Depth							
	30"		36"		42"		48"	
	Capacity	Part No.	Capacity	Part No.	Capacity	Part No.	Capacity	Part No.
48"	1675 lb	WSDPB4830	1350 lb	WSDPB4836	1025 lb	WSDPB4842	700 lb	WSDPB4848
60"	1675 lb	WSDPB6030	1350 lb	WSDPB6036	1025 lb	WSDPB6042	700 lb	WSDPB6048
72"	2500 lb	WSDPB7230	2025 lb	WSDPB7236	1525 lb	WSDPB7242	1050 lb	WSDPB7248
84"	2500 lb	WSDPB8430	2025 lb	WSDPB8436	1525 lb	WSDPB8442	1050 lb	WSDPB8448
96"	3300 lb	WSDPB9630	2700 lb	WSDPB9636	2050 lb	WSDPB9642	1400 lb	WSDPB9648

*All capacities listed are for evenly distributed loads with required number of Front To Back Supports.

**Solid Steel Decking, Ribbed Decking, Waterfall Wire Decking, and Flat Wire Decking have been designed and tested with L/140 maximum deflection and 1.5 safety factor.

STEP 3 Select **Decking** (continued).

RIBBED DECKING

In addition to standard sizes, available in:

- Depths in 1" increments between 15" and 48"



Functional 20-gauge steel ribbed decking. The $\frac{5}{8}$ " deep rib provides space for hands to easily grip items on shelf.

RIBBED DECKING PART NUMBERS & CAPACITIES

Width	Depth							
	15"		18"		24"		30"	
	Capacity	Part No.	Capacity	Part No.	Capacity	Part No.	Capacity	Part No.
24"	1775 lb	WSDSR2415	1650 lb	WSDSR2418	1400 lb	WSDSR2424	1150 lb	WSDSR2430
36"	2175 lb	WSDSR3615	2050 lb	WSDSR3618	1800 lb	WSDSR3624	1550 lb	WSDSR3630

Width	Depth							
	30"		36"		42"		48"	
	Capacity	Part No.	Capacity	Part No.	Capacity	Part No.	Capacity	Part No.
24"	1150 lb	WSDSR2430	925 lb	WSDSR2436	675 lb	WSDSR2442	450 lb	WSDSR2448
36"	1550 lb	WSDSR3630	1300 lb	WSDSR3636	1025 lb	WSDSR3642	775 lb	WSDSR3648

WATERFALL WIRE DECKING

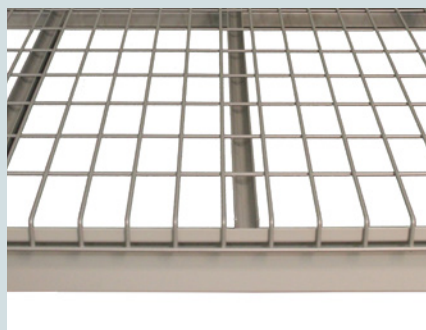

Wire decking made of wire mesh, strengthened with heavy gauge welded rows, and reinforced with 1 $\frac{1}{2}$ " waterfall along front and back edge.

WATERFALL WIRE DECKING PART NUMBERS & CAPACITIES

Width	Depth					
	24"		30"		36"	
	Capacity	Part No.	Capacity	Part No.	Capacity	Part No.
24"	1550 lb	WSDWW2424	1325 lb	WSDWW2430	1100 lb	WSDWW2436
36"	1550 lb	WSDWW2436	1325 lb	WSDWW2430	1100 lb	WSDWW2436

Width	Depth					
	36"		42"		48"	
	Capacity	Part No.	Capacity	Part No.	Capacity	Part No.
24"	1100 lb	WSDWW2436	875 lb	WSDWW2442	650 lb	WSDWW2448
36"	1100 lb	WSDWW2436	875 lb	WSDWW2442	650 lb	WSDWW2448

FLAT WIRE DECKING

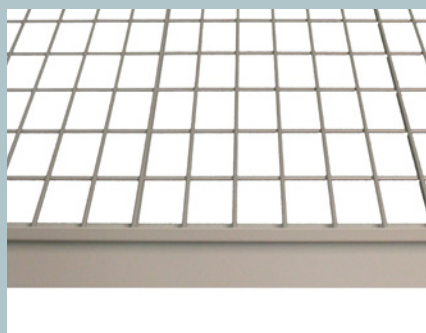

Decking made of wire mesh, reinforced with welded wires.

FLAT WIRE DECKING PART NUMBERS & CAPACITIES

Width	Depth					
	24"		30"		36"	
	Capacity	Part No.	Capacity	Part No.	Capacity	Part No.
24"	120 lb	WSDWF2424	105 lb	WSDWF2430	90 lb	WSDWF2436
36"	180 lb	WSDWF3624	155 lb	WSDWF3630	130 lb	WSDWF3636

Width	Depth					
	36"		42"		48"	
	Capacity	Part No.	Capacity	Part No.	Capacity	Part No.
24"	90 lb	WSDWF2436	75 lb	WSDWF2442	60 lb	WSDWF2448
36"	130 lb	WSDWF3636	105 lb	WSDWF3642	80 lb	WSDWF3648

STEP 4 Select Front To Back Supports.

One to four supports per level are required based on beam width and type of decking.

MINIMUM REQUIRED when used with:		
Beam Width	Particle Board	Solid, Ribbed, or Wire Decking
48" - 60"	2	1
61" - 84"	3	2
85" - 96"	4	2

In addition to standard sizes, Front To Back Supports are available in depths of 1" increments between 15" and 48"



FRONT-TO-BACK SUPPORTS	
Length	Part No.
15"	WSBFBS15
18"	WSBFBS18
24"	WSBFBS24
30"	WSBFBS30
36"	WSBFBS36
42"	WSBFBS42
48"	WSBFBS48

STEP 5 Select Accessories.



ANCHORING FOOT

To anchor an upright assembly to floor.

Part No.	WSUAF
----------	-------



BACK TO BACK TIE PLATE

Ties wide span uprights back to back for steady, even spacing, and additional stability.

	Part No.	Spacing Length
Without Adjustable Beam	WSUTP	3/8"
With Adjustable Beam	WSUTPA	1 1/4"
Without Adjustable Beam for piggyback welded carriage	WSUTPWPC	3/4"



UPRIGHT SPLICE

Use for two-level wide span shelving applications. Upright Splice is inserted into bottom upright posts and second-level upright posts are fit over channel extensions.

Part No.	WSUSPLICE
----------	-----------



BACK TO BACK SUPPORTS

Connects wide span uprights back to back, conveniently secures spacing between for added support.

Length	Part No.
6"	WSUBBS06
12"	WSUBBS12
18"	WSUBBS18



BACK TO WALL SUPPORTS

Connects upright assembly and wall to support and stabilize shelves.

Length	Part No.
6"	WSUBWS06
12"	WSUBWS12
18"	WSUBWS18

UPRIGHTS

Welded Upright
WSWU2YYZZZ

Knock-Down Upright
WSWKDUYYZZZ

Ladder Brace
WSLBXX

WS= Wide Span
W= Welded
KD= Knock Down
U= Upright
LB= Ladder Brace
YY= Depth
ZZZ=Height
XX= Length

Example:
Wide Span Welded Upright,
36" deep x 97.5" tall:
WSWU2360975

BEAMS

Standard Duty Beam
WSBSXX

Heavy Duty Beam
WSBHDXX

Low Profile Beam
WSBLDXX

WS= Wide Span
B= Beam
S= Standard Duty
HD= Heavy Duty
LD= Low Profile
XX= Length

FRONT-TO-BACK SUPPORTS

Front-to-Back Support
WSBFBSXX

WS= Wide Span
B= Beam
FBS= Front-to-Back Support
XX= Length/Rack Depth

DECKING

Solid Steel Decking
WSDSSXXYY

Particle Board Decking
WSPBXXYY

Steel Ribbed Decking
WSDSRXXYY

Waterfall Wire Decking
WSDWWXXYY

Flat Wire Decking
WSDWFXXYY

WS= Wide Span
D= Decking
SS= Solid Steel Shelving
PB= Particle Board
SR= Steel Ribbed
WW= Waterfall Wire
WF= Flat Wire
XX= Width
YY= Depth

ACCESSORIES

Upright Anchoring Foot
WSUAF

Upright Tie Plate
without Adjustable Beams
WSUTP

Upright Tie Plate
with Adjustable Beams
WSUTPA

Upright Splice
WSUSPLICE

Back-to-Back Supports
WSUBBSXX

Back-to-Wall Supports
WSUBWSXX

WS= Wide Span
U= Upright
AF= Anchoring Foot
TP= Tie Plate
A= Adjustable Beam
SPLICE= Upright Splice
BBS= Back-to-Back Support
BWS= Back-to-Wall Support
XX= Length



Smart. Storage. Solutions.

www.BRADFORDSYSTEMS.com

Bradford Systems
Corporate Offices
430 Country Club Drive
Bensenville, Illinois 60106
1-800-696-3453

Spacesaver Corporation is a division of KI.

KI and Spacesaver are registered trademarks of Krueger International, Inc.

© 2015 KI and Spacesaver Corporation. All Rights Reserved. Litho in USA. WideSpanShelving_1114_ProductCatalog